









Robolux multiway multiport diaphragm valve, pneumatically operated

- Allows optimized processes designs
- Reduced installation costs
- Reduced number of valves and welds
- Stainless steel bodies in different configurations
- Approvals FDA, CE, USP VI, ATEX/IECEX, 3.1

Product variants described in the data sheet may differ from the product presentation and description.

Can be combined with

	Type 8685 ▶ Control- and feedback head for integrated mounting on Robolux valves Type 2036
	Type 8686 ▶ Control- and feedback head for integrated mounting on Robolux valves Type 2036
	Type 2103 ▶ Pneumatically operated 2/2 way diaphragm valve ELEMENT for decentralized automation
	Type 2034 ▶ Multifunction Block and Weld Solution
	Type 8652 ▶ AirLINE - the valve island optimised for process automation
	Type 8098 ▶ FLOWave SAW flow-meter

Type description

This multiway multiport diaphragm valve system is designed for control of ultra pure, sterile, aseptic and steam/CIP fluid paths. It enables optimal sampling, draining or diverting of critical process fluids.

The valve range is based on the patented Robolux technology, where two seats are placed under one diaphragm. This design eliminates dead legs and will minimize the flow system volume.

The valve body is machined from a single piece of bar stock stainless steel. The high quality diaphragms are available in several different USP class VI approved materials. The valve is operated with compressed air.

With the feedback and control heads the Robolux fits perfectly into Bürkert's decentralized automation concept. All valves will be delivered with 3.1 certificate, installation drawing and operating manual.

Table of contents

1. General Technical Data	3
2. Approvals	4
3. Materials	4
3.1. Chemical Resistance Chart – Bürkert resistApp.....	4
4. Dimensions	5
4.1. 3 Connections 2 Seats: 3C2S (32R) and 4 Connections 2 Seats: 4C2S (42R).....	5
4.2. 4 Connections 4 Seats CF: 4C4S CF (44C).....	6
4.3. 4 Connections 4 Seats DFP: 4C4S DFP (44D)	7
4.4. Valve system on/off Robolux Type 8806-DI.....	8
5. Performance specifications	8
5.1. Medium pressure	8
5.2. Valve symbols and flow patterns	9
6. Product operation	10
6.1. Draining operation of the valve	10
7. Product accessories	11
8. Networking and combination with other Bürkert products	12
9. Ordering information	12
9.1. Bürkert eShop – Easy ordering and quick delivery.....	12
9.2. Bürkert product filter	12



1. General Technical Data

Product properties	
Dimensions	Detailed information can be found in chapter "4. Dimensions" on page 5
Material	
Body	1.4435 stainless steel (316L)
Diaphragm	EPDM (AD), advanced PTFE/EPDM laminated (EK), GYLON®/EPDM laminated (ER)
Actuator	1.4308 stainless steel (CF8)
Standard surface quality ^{1.)}	
Internal mechanically polished	Ra ≤ 0.5 µm (ASME BPE SF1) (external Ra ≤ 1.6 µm)
Internal electrically polished	Ra ≤ 0.38 µm (ASME BPE SF4 / DIN HE4) (external Ra ≤ 1.6 µm)
Performance data	
Pilot pressure	6...10 bar for RV50/70 6...7 bar for RV110
Pilot air ports	Thread G 1/8"
Medium data	
Operating medium	Natural gases and fluids, extremely pure, sterile, aggressive or abrasive mediums
Medium pressure	Max. 8 bar (dependent on actuator and diaphragm see "5.1. Medium pressure" on page 8).
Control medium	Neutral gases, air
Medium temperature	
EPDM (AD) ^{1.)}	+5...+130 °C (steam sterilization + 140 °C for 60 min)
Advanced PTFE/EPDM laminated (EK) ^{1.)}	+5...+90 °C (not recommended for steam)
GYLON®/EPDM laminated (ER) ^{1.)}	+15...+130 °C (steam sterilization + 140 °C for 60 min)
Product connections	
Nominal diameter	1/4" ... 2", DN 4...DN 50
Port connections ^{2.)}	
Welded connection ^{2.)}	DIN EN ISO 1127 / ISO 4200 / DIN 11866 series B DIN 11850 series 2 / DIN 11866 series A / DIN EN 10357 series A ASME BPE / DIN 11866 series C
Clamp connection ^{2.)}	DIN 32676 series A (DIN pipe) DIN 32676 series B (ISO pipe) ASME BPE
Environment and installation	
Installation position	See operating manual
Ambient temperature	0...+60 °C

1.) This information is part of the product key.

2.) Further versions on request.

2. Approvals

Approvals ^{1.)}	Description
FDA	The diaphragms made of EPDM (AD), advanced PTFE/EPDM laminated (EK) and GYLON®/EPDM laminated (ER) comply with the Code of Federal Regulations published by the FDA (Food and Drug Administration, USA).
	The diaphragms made of EPDM (AD), advanced PTFE/EPDM laminated (EK) and GYLON®/EPDM laminated (ER) are suitable for use with food and beverages (acc. to EC Regulation 1935/2004/EC)
	The diaphragms made of EPDM (AD), advanced PTFE/EPDM laminated (EK) and GYLON®/EPDM laminated (ER) are acc. to USP Class VI approved.
	ATEX / IECEx: EPS 18 ATEX 2 008 X II 2G Ex h IIC T4 Gb / II 2D Ex h IIIC T135 °C Db IECEx EPS 18.0007X Ex h IIC T4 Gb / Ex h IIIC T135 °C Db

1.) Further versions on request

3. Materials

3.1. Chemical Resistance Chart – Bürkert resistApp

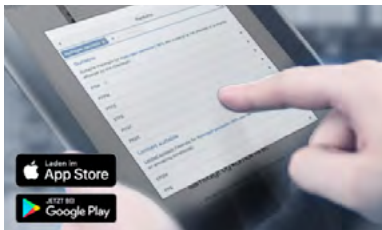

Bürkert resistApp – Chemical Resistance Chart

You want to ensure the reliability and durability of the materials in your individual application case? Verify your combination of media and materials on our website or in our resistApp.

[Start Chemical Resistance Check](#)

4. Dimensions

4.1. 3 Connections 2 Seats: 3C2S (32R) and 4 Connections 2 Seats: 4C2S (42R)

Note:

- For more information on the valve symbols and flow diagrams see “5.2. Valve symbols and flow patterns” on page 9.
- The specifications 32R and 42R are part of the product key.
- Measurement L1 or L2 applies to all housing connections
- Dimensions in mm, unless otherwise stated

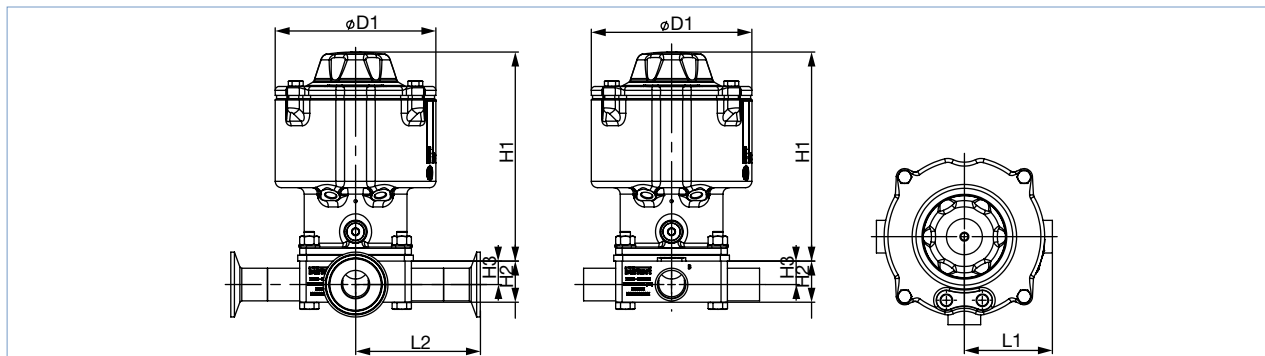

DN [mm]	DN [inch]	Actuator size	ØD1	H1	H2	H3	Welded connection		Clamp connection	
							D x s	L1	Dcl, Da x s	L2
							DIN EN ISO 1127 / ISO 4200 / DIN 11866 series B		DIN 32676 series B (ISO pipe)	
6	-	RV50	83	126.5	16	9.9	10.2 × 1.6	52.5	-	-
8	-	RV50	83	126.5	16	8.3	13.5 × 1.6	52.5	25.0, 13.5x1.6	81.1
10	-	RV50	83	126.5	21	11.4	17.2 × 1.6	52.5	25.0, 17.2x1.6	81.1
15	-	RV50	83	126.5	26	14.4	21.3 × 1.6	52.5	50.5, 21.3x1.6	81.1
20	-	RV70	125	162.5	32	17.6	26.9 × 1.6	68.5	50.5, 26.9x1.6	97.1
25	-	RV110	171	193	38	20.2	33.7 × 2.0	90	50.5, 33.7x2.0	118.6
32	-	RV110	171	193	56	33.8	42.4 × 2.0	90	64.0, 42.4x2.0	118.6
40	-	RV110	171	193	56	30.9	48.3 × 2.0	90	64.0, 48.3x2.0	118.6
50	-	RV110	171	193	62 (3C2S) 68 (4C2S)	30.9 (3C2S) 36.9 (4C2S)	60.3 × 2.0	90	77.5, 60.3x2.0	118.6
							DIN 11850 series 2 / DIN 11866 series A / DIN EN 10357 series A		DIN 32676 series A (DIN pipe)	
4	-	RV50	83	126.5	16	12	6.0 × 1.0	52.5	-	-
6	-	RV50	83	126.5	16	11	8.0 × 1.0	52.5	-	-
8	-	RV50	83	126.5	16	10	10.0 × 1.0	52.5	-	-
10	-	RV50	83	126.5	16	8.5	13.0 × 1.5	52.5	34.0, 13.0x1.5	70.5
15	-	RV50	83	126.5	21	10.5	19.0 × 1.5	52.5	34.0, 19.0x1.5	70.5
20	-	RV70	125	162.5	26	13.5	23.0 × 1.5	68.5	34.0, 23.0x1.5	86.5
25	-	RV70	125	162.5	32	16.5	29.0 × 1.5	68.5	50.5, 29.0x1.5	90
32	-	RV110	171	193	38	19.5	35.0 × 1.5	90	50.5, 35.0x1.5	111.5
40	-	RV110	171	193	44	22.5	41.0 × 1.5	90	50.5, 41.0x1.5	111.5
50	-	RV110	171	193	62	34.5	53.0 × 1.5	90	64.0, 53.0x1.5	111.5
							ASME BPE / DIN 11866 series C		ASME BPE	
8	¼"	RV50	83	126.5	16	11.8	6.35 × 0.89	52.5	25.0, 6.35x0.89	81.1
10	⅜"	RV50	83	126.5	16	10.2	9.53 × 0.89	52.5	25.0, 9.53x0.89	81.1
15	½"	RV50	83	126.5	16	8.7	12.7 × 1.65	52.5	25.0, 12.7x1.65	81.1
20	¾"	RV50	83	126.5	21	10.5	19.05 × 1.65	52.5	25.0, 19.05x1.65	81.1
25	1"	RV70	125	162.5	32	18.3	25.4 × 1.65	68.5	50.5, 25.4x1.65	97.1
40	1½"	RV110	171	193	44	24	38.1 × 1.65	90	50.5, 38.1x1.65	118.6
50	2"	RV110	171	193	56 (3C2S) 58 (4C2S)	29.6 (3C2S) 31.6 (4C2S)	50.8 × 1.65	90	64.0, 50.8x1.65	118.6

4.2. 4 Connections 4 Seats CF: 4C4S CF (44C)

Note:

- For more information on the valve symbols and flow diagrams see “5.2. Valve symbols and flow patterns” on page 9.
- The specification **44C** is part of the product key.
- Measurements L1-L5 and H3-H4 apply to all housing connections
- Dimensions in mm, unless otherwise stated

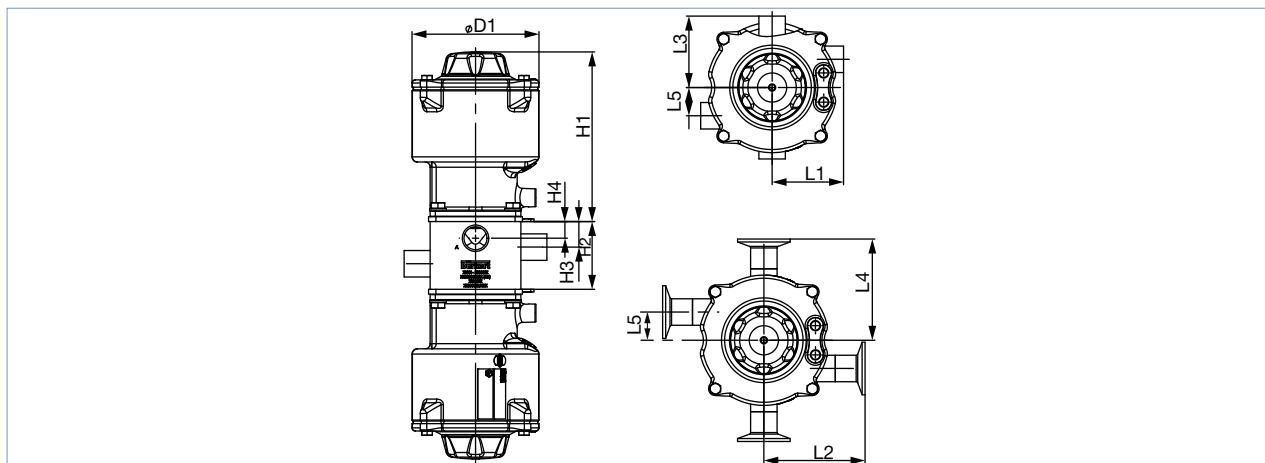

DN [mm]	DN [inch]	Actuator size	ØD1	H1	H2	H3	H4	L5	Welded connection			Clamp connection		
									D x s	L1	L3	Dcl, Da x s	L2	L4
									DIN EN ISO 1127 / ISO 4200 / DIN 11866 series B			DIN 32676 series B (ISO pipe)		
6	-	RV50	83	126.5	40	18.5	11.5	20.5	10.2x1.6	52.5	52.5	-	-	-
8	-	RV50	83	126.5	42	19	9.9	13.6	13.5x1.6	52.5	52.5	25.0, 13.5x1.6	81.1	81.1
10	-	RV50	83	126.5	50	21.5	12	18.2	17.2x1.6	52.5	52.5	25.0, 17.2x1.6	81.1	-
15	-	RV50	83	126.5	58	25.5	11.7	12.2	21.3x1.6	52.5	52.5	50.5, 21.3x1.6	81.1	81.1
20	-	RV70	125	162.5	67	25.5	15.2	27.8	26.9x1.6	68.5	68.5	50.5, 26.9x1.6	97.1	97.1
25	-	RV110	171	193	91	35	24.2	40.1	33.7x2.0	90	90	50.5, 33.7x2.0	118.6	118.6
32	-	RV110	171	193	106	42	22.5	44	42.4x2.0	90	91.5	64.0, 42.4x2.0	118.6	-
40	-	RV110	171	193	120	46.5	26	47.1	48.3x2.0	90	98.2	64.0, 48.3x2.0	118.6	126.8
50	-	RV110	171	193	147	53.5	32	53.1	60.3x2.0	90	110.2	77.5, 60.3x2.0	118.6	138.8
									DIN 11850 series 2 / DIN 11866 series A / DIN EN 10357 series A			DIN 32676 series A (DIN pipe)		
4	-	RV50	83	126.5	40	18.5	13	22	6.0x1.0	52.5	52.5	-	-	-
6	-	RV50	83	126.5	40	18.5	12	21	8.0x1.0	52.5	52.5	-	-	-
8	-	RV50	83	126.5	40	18.5	11	20	10.0x1.0	52.5	52.5	-	-	-
10	-	RV50	83	126.5	40	19	9	19	13.0x1.5	52.5	52.5	34.0, 13.0x1.5	81.1	81.1
15	-	RV50	83	126.5	54	23.5	11.9	13.3	19.0x1.5	52.5	52.5	34.0, 19.0x1.5	81.1	81.1
20	-	RV70	125	162.5	62	22.5	17	26	23.0x1.5	68.5	68.5	34.0, 23.0x1.5	86.5	86.5
25	-	RV70	125	162.5	73	27.5	16.5	29	29.0x1.5	68.5	69.5	50.5, 29.0x1.5	90	91
32	-	RV110	171	193	95	37	23	41	35.0x1.5	90	90	50.5, 35.0x1.5	111.5	111.5
40	-	RV110	171	193	104	41.5	22	33	41.0x1.5	90	91	50.5, 41.0x1.5	111.5	112.5
50	-	RV110	171	193	134	50.5	30	50	53.0x1.5	90	103.5	64.0, 53.0x1.5	111.5	125
									ASME BPE / DIN 11866 series C			ASME BPE		
8	¼"	RV50	83	126.5	40	18.5	12.5	21.7	6.35x0.89	52.5	52.5	25.0, 6.35x0.89	81.1	81.1
10	⅜"	RV50	83	126.5	40	18.5	11	20.1	9.53x0.89	52.5	52.5	25.0, 9.53x0.89	81.1	81.1
15	½"	RV50	83	126.5	40	8.5	10.3	13.2	12.7x1.65	52.5	52.5	25.0, 12.7x1.65	81.1	81.1
20	¾"	RV50	83	126.5	53	22.5	12	13.4	19.05x1.65	52.5	52.5	25.0, 19.05x1.65	81.1	81.1
25	1"	RV70	125	162.5	65	24.5	16	27	25.4x1.65	68.5	68.5	50.5, 25.4x1.65	97.1	97.1
40	1½"	RV110	171	193	98	39	21.6	42.4	38.1x1.65	90	90	50.5, 38.1x1.65	118.6	118.6
50	2"	RV110	171	193	126	48.5	27.7	48.7	50.8x1.65	90	101	64.0, 50.8x1.65	118.6	129.6

DTS 1000215411 EN Version: H Status: RL (released | freigegeben | valide) printed: 27.08.2020

4.3. 4 Connections 4 Seats DFP: 4C4S DFP (44D)

Note:

- For more information on the valve symbols and flow diagrams see “5.2. Valve symbols and flow patterns” on page 9.
- The specification **44D** is part of the product key.
- Measurement L1 or L2 applies to all housing connections
- Dimensions in mm, unless otherwise stated

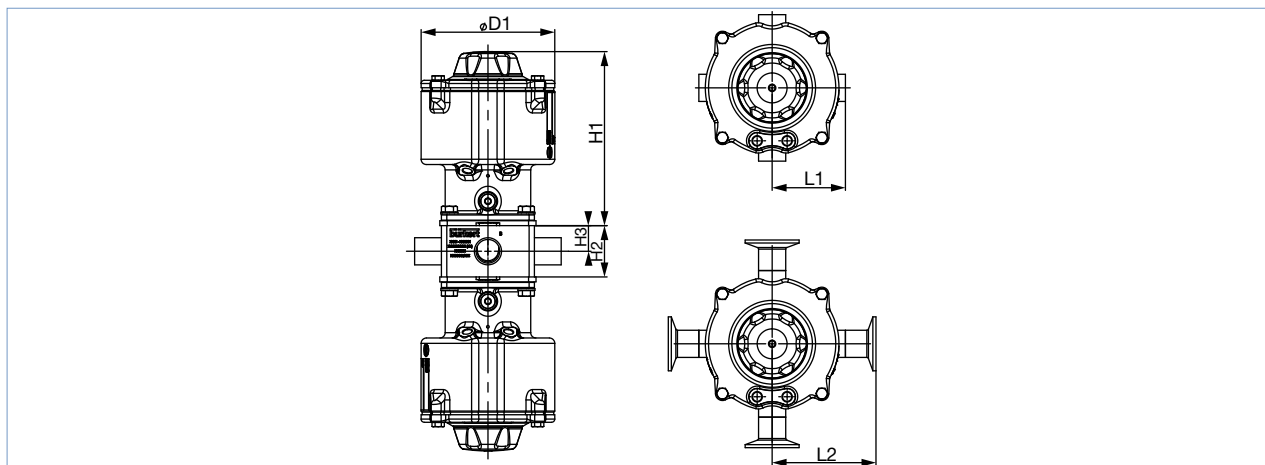

DN [mm]	DN [inch]	Actuator size	ØD1	H1	H2	H3	Welded connection		Clamp connection	
							D x s	L1	Dcl, Da x s	L2
							DIN EN ISO 1127 / ISO 4200 / DIN 11866 series B		DIN 32676 series B (ISO pipe)	
6	–	RV50	83	126.5	28	14	10.2×1.6	52.5	–	–
8	–	RV50	83	126.5	28	14	13.5×1.6	52.5	25.0, 13.5x1.6	81.1
10	–	RV50	83	126.5	34	17	17.2×1.6	52.5	25.0, 17.2x1.6	81.1
15	–	RV50	83	126.5	34	17	21.3×1.6	52.5	50.5, 21.3x1.6	81.1
20	–	RV70	125	162.5	48	24	26.9×1.6	68.5	50.5, 26.9x1.6	97.1
25	–	RV110	171	193	65	32.5	33.7×2.0	90	50.5, 33.7x2.0	118.6
32	–	RV110	171	193	65	32.5	42.4×2.0	90	64.0, 42.4x2.0	118.6
40	–	RV110	171	193	70	35	48.3×2.0	90	64.0, 48.3x2.0	118.6
50	–	RV110	171	193	70	35	60.3×2.0	90	77.5, 60.3x2.0	118.6
							DIN 11850 series 2 / DIN 11866 series A / DIN EN 10357 series A		DIN 32676 series A (DIN pipe)	
4	–	RV50	83	126.5	28	14	6.0×1.0	52.5	–	–
6	–	RV50	83	126.5	28	14	8.0×1.0	52.5	–	–
8	–	RV50	83	126.5	28	14	10.0×1.0	52.5	–	–
10	–	RV50	83	126.5	28	14	13.0×1.5	52.5	34.0, 13.0x1.5	70.5
15	–	RV50	83	126.5	34	17	19.0×1.5	52.5	34.0, 19.0x1.5	70.5
20	–	RV70	125	162.5	48	24	23.0×1.5	68.5	34.0, 23.0x1.5	86.5
25	–	RV70	125	162.5	48	24	29.0×1.5	68.5	50.5, 29.0x1.5	90
32	–	RV110	171	193	65	32.5	35.0×1.5	90	50.5, 35.0x1.5	111.5
40	–	RV110	171	193	70	35	41.0×1.5	90	50.5, 41.0x1.5	111.5
50	–	RV110	171	193	70	35	53.0×1.5	90	64.0, 53.0x1.5	111.5
							ASME BPE / DIN 11866 series C		ASME BPE	
8	¼"	RV50	83	126.5	28	14	6.35×0.89	52.5	25.0, 6.35x0.89	81.1
10	⅜"	RV50	83	126.5	28	14	9.53×0.89	52.5	25.0, 9.53x0.89	81.1
15	½"	RV50	83	126.5	28	14	12.7×1.65	52.5	25.0, 12.7x1.65	81.1
20	¾"	RV50	83	126.5	34	17	19.05×1.65	52.5	25.0, 19.05x1.65	81.1
25	1"	RV70	125	162.5	48	24	25.4×1.65	68.5	50.5, 25.4x1.65	97.1
40	1½"	RV110	171	193	70	35	38.1×1.65	90	50.5, 38.1x1.65	118.6
50	2"	RV110	171	193	70	35	50.8×1.65	90	64.0, 50.8x1.65	118.6

4.4. Valve system on/off Robolux Type 8806-DI

Note:

- Type 8806-DI-S with feedback head Type 8685 (shown on the left)
- Type 8806-DI-T with control head Type 8686 (shown on the right)
- Body measurements see “4. Dimensions” on page 5.
- Dimensions in mm

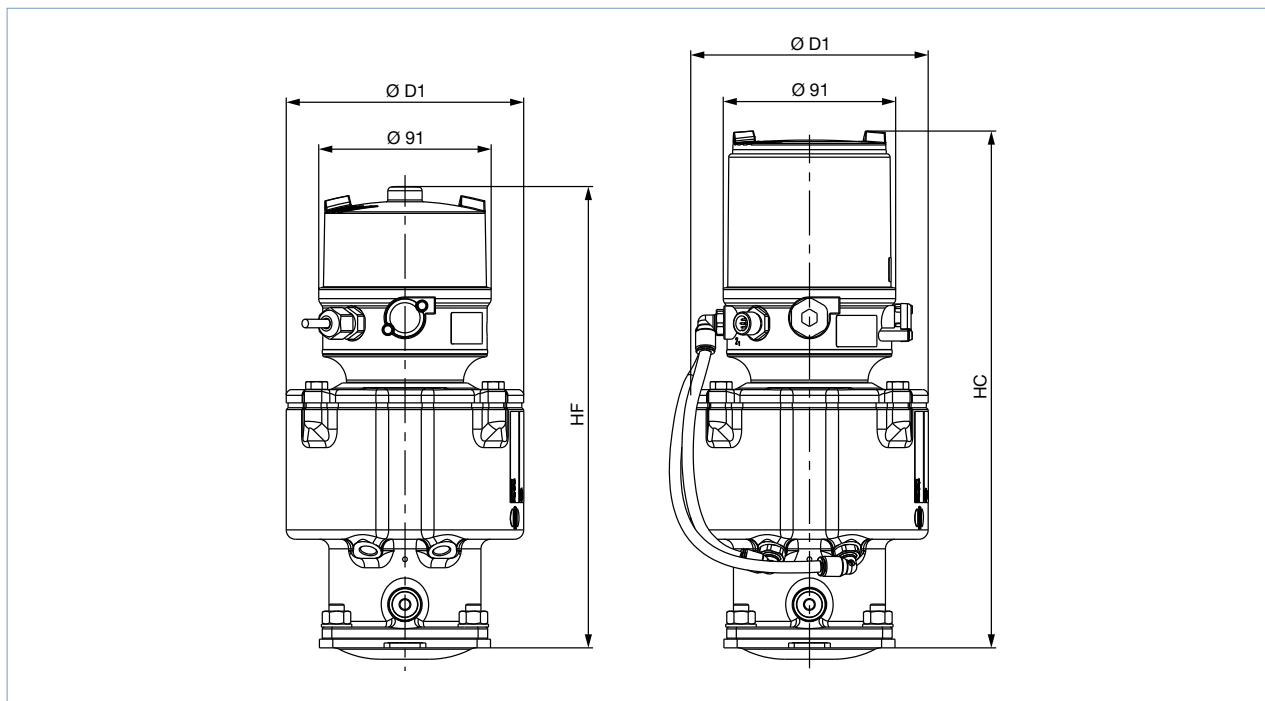

Actuator size	ØD1	HF	HC
RV50	83	214.5	243.5
RV70	125	242.5	272
RV110	171	273	302.5

5. Performance specifications

5.1. Medium pressure

Note:

For more information on the max. operating pressure, refer to the [operating instructions](#).

Actuator size	Actuator version	Seat tightness/medium pressure [bar] - diaphragm		
		EPDM	Advanced PTFE laminated	Gylon® laminated
RV50	D11	7.5	7.5	5.5
	D55 (reduced spring force)	5.0	3.5	On request
RV70	D11, D1x, Dx1	8.0	8.0	5.5
	D55 (reduced spring force)	5.5	6.0	4.5
RV110	D11, D1x, Dx1	7.0	7.5	6.0
	D55 (reduced spring force)	5.0	5.0	4.0

5.2. Valve symbols and flow patterns

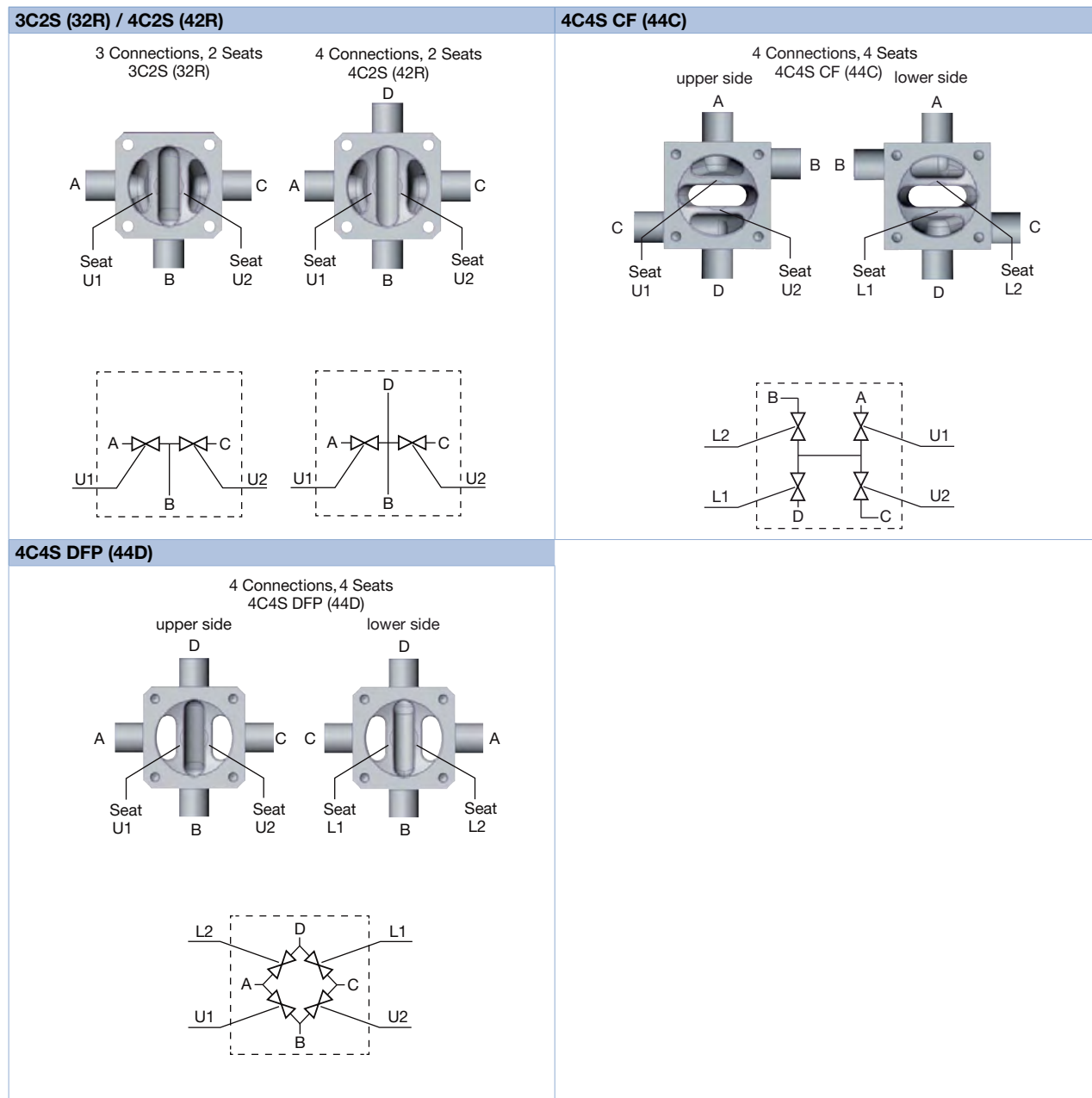

DTS 1000215411 EN Version: H Status: RL (released | freigegeben | valide) printed: 27.08.2020

6. Product operation

6.1. Draining operation of the valve

The draining is achieved differently depending on the valve type. It is very important to fully understand the flow paths of each individual valve body before deciding which port/connection (marked with A, B, C or D) to select for draining. Consult with your Bürkert contact person if there are any questions. The examples below show how to get the optimum draining for the 3C2S/4C2S and 4C4S.

Self-draining 3C2S (32R) / 4C2S (42R)	Self-draining 4C4S CF (44C)
<p>Installation position for self-draining:</p> <div style="display: flex; justify-content: space-around;"> <div style="text-align: center;"> <p>3C2S / 4C2S Drain connection B (D)</p> </div> <div style="text-align: center;"> <p>3C2S / 4C2S Drain connection C (A)</p> </div> </div> <div style="text-align: center; margin-top: 10px;"> </div>	<p>Installation position for self-draining:</p> <div style="text-align: center;"> <p>4C4S CF Drain connection D</p> </div> <div style="text-align: center; margin-top: 10px;"> </div>
Self-draining 4C4S DFP (44D)	
<p>Installation position for self-draining:</p> <div style="display: flex; justify-content: space-around;"> <div style="text-align: center;"> <p>4C4S DFP Drain connection A (C)</p> </div> <div style="text-align: center;"> <p>4C4S DFP Drain connection B (D)</p> </div> </div> <div style="text-align: center; margin-top: 10px;"> </div>	

DTS 1000215411 EN Version: H Status: RL (released | freigegeben | valide) printed: 27.08.2020

7. Product accessories

Position feedback head	Description
	<p>Type 8685 ▶</p> <p>The feedback head Type 8685 is designed for combination with actuators of the process valve series Type 2036. Robolux valves have been specially designed to meet the requirements of hygienic process environments.</p> <p>The feedback head with electrical feedback is also available in ASI and is intrinsically safe according to ATEX / IECEx.</p> <p>Customer benefits</p> <ul style="list-style-type: none"> • Adjustment to the individual actuator size is done through DIP switches. • The devices contain the complete automation functionality of the two individually operated actuator pistons. • Visual position feedback is done by non-contact switches and high-power LEDs. • Hygienic design, materials are chemically resistant against cleaning media and a proven electrical IP protection. • Standard version, 24 V DC.
<p>End position indicators 2x Open, 2x Closed</p>	<p>Approvals</p> <ul style="list-style-type: none"> • ATEX: IIG Ex ia IIC T4 Gb • IECEx: Ex ia IIC T4 Gb
Control head	Description
	<p>Type 8686 ▶</p> <p>The Type 8686 control head is designed for combination with actuators of the Type 2036 process valve series. Robolux valves have been specially designed to meet the requirements of hygienic process environments.</p> <p>The control head which combines electrical position feedback and pneumatic control is also available in ASI and is intrinsically safe according to ATEX / IECEx.</p> <p>Kundennutzen</p> <ul style="list-style-type: none"> • The adjustment to the individual actuator size is made via DIP switches. • The devices perform the automation functions for the two independently controllable actuator pistons. • Optical position feedback via non-contact switches and high-power LEDs. • An air intake filter increases the availability of the valve system. • Hygienic design, materials resistant to cleaning agents and a proven IP protection. <p>Standard version 24 V DC.</p>
<p>End position indicators • 2x Open, 2x Closed</p>	<p>Approvals</p> <ul style="list-style-type: none"> • ATEX: IIG Ex ia IIC T4 Gb • IECEx: Ex ia IIC T4 Gb

8. Networking and combination with other Bürkert products

A Valve system On/Off Robolux Type 8806 consists of a diaphragm valve Type 2036 and a position feedback head Type 8685 ▶ or a control head Type 8686 ▶ (see corresponding datasheet). You order two components and receive a complete assembled and certified valve.

Note:

You can find further information on the control and position feedback head in chapter “7. Product accessories” on page 11.

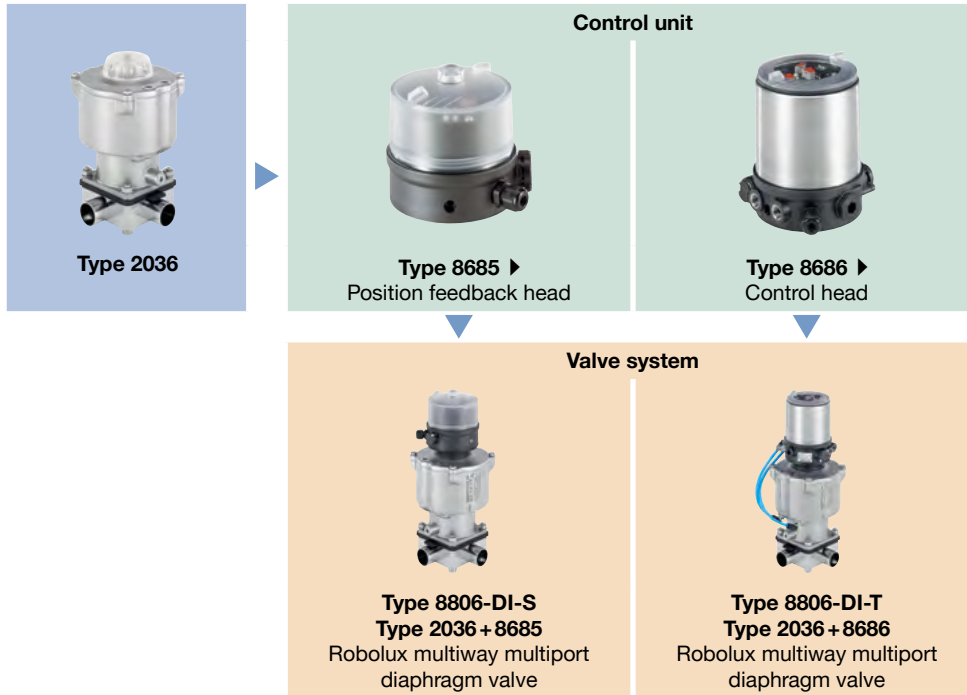

9. Ordering information

9.1. Bürkert eShop – Easy ordering and quick delivery



Bürkert eShop – Easy ordering and fast delivery

You want to find your desired Bürkert product or spare part quickly and order directly? Our online shop is available for you 24/7. Sign up and enjoy all the benefits.

[Order online now](#)

9.2. Bürkert product filter

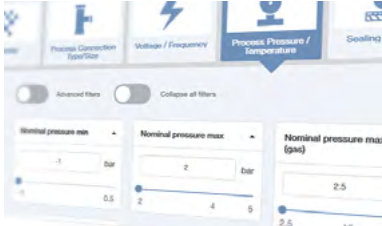

Bürkert product filter – Get quickly to the right product

You want to select products comfortably based on your technical requirements? Use the Bürkert product filter and find suitable articles for your application quickly and easily.

[Try out our product filter](#)

Bürkert – Close to You

For up-to-date addresses
please visit us at
www.burkert.com

DTS 1000215411 EN Version: H Status: RL (released | freigegeben | validé) printed: 27.08.2020



Product Enquiry Form - Robolux multiway multiport diaphragm valve

Thank you for your interest in our products! In order to provide you with optimum advice, please fill out the following form and send it to your **Bürkert representative** or e-mail address: info@burkert.com. All information submitted will of course be kept strictly confidential.

Please fill in the **required fields!** *

*Note: The interactive functions of this PDF may be restricted depending on the PDF reader used.

Personal Information			
Company		Contact person	
Customer no.		Department	
Street		Postcode / Town	
Telephone no.		Email	

Delivery	
Quantity	Required delivery date

Operating data					
Operating medium					
Medium	Fluid	Steam	Gas	CIP	SIP
Medium temperature	T _{med}				
Medium pressure	P _{med}				

Valve data				
Surface quality	Standard:	Ra 0.5 internal	Ra 0.38 e-pol internal	
	No Standard:	internal	external	
Housing material				
Seal material	EPDM	advanced PTFE	GYLON®	others
DN	DN			
Pilot pressure	Min.		Max.	
Connection	Welded connection	EN ISO 1127 / ISO 4200 DIN 11866 R. B	DIN 11850 DIN 11866 R. A	ASME BPE DIN 11866 R. C
	Clamp connection	DIN 32676 R. B (ISO pipe (ISO4200))	DIN 32676 R. A (DIN pipe (DIN11850))	ASME BPE
	Other			

Article no. (if known)

Additional Requirements / Comment

DTS 1000215411 EN Version: H Status: RL (released | freigegeben | valide) printed: 27.08.2020

Specification key

Note:

- Please fill out this Product Enquiry Form as completely as possible to avoid further inquiries.
- For Valve Systems Open/Close or Continuous, please also fill out the **Product Enquiry Form Control Heads and Positioners** ▶.
- For more complex valve body constellations, please refer to Multi Function Block **Type 2034** ▶.
- The explanation of the key number can be found in the **Key Legend** on the following pages.

	Quantity	Type	Body design	Valve size	Diaphragm material	Housing material	Port connection	Version actuator 1	Version actuator 2		Variable	Variable	Variable
Key Feature		TYP	GBR	VG	DWST	WKST	LTA	ATR1	ATR2	*	VAR1	VAR2	VAR3
Key number →		1	2	3	4	5	6	7	7		V1	V2	V3

Example													
Type 2036 ▶ Robolux multiway multiport diaphragm valve, pneumatically operated	1	2036	32R	70.0	AD	VH	SA93	D11	000	*	NK52	NO14	-
1 Selection →		2036								*	NK52		
Remarks													
2 Selection →		2036								*	NK52		
Remarks													
3 Selection →		2036								*	NK52		
Remarks													
4 Selection →		2036								*	NK52		
Remarks													
5 Selection →		2036								*	NK52		
Remarks													
6 Selection →		2036								*	NK52		
Remarks													

DTS 1000215411 EN Version: H Status: RL (released | freigegeben | valide) printed: 27.08.2020

Key Legend

Note:

Other versions on request

Key number 2: Body design (GBR)		Key number V1, V2, ...: Variable code (VAR1, VAR2, VAR3)	
32R	3 Connections, 2 seats	NK52	Acceptance test certificate 3.1 according to EN 10204
32T	3 Connections, 2 seats, tank bottom version	NO14	Mechanically polished Ra ≤ 0.5 µm (ASME BPE SF1)
42R	4 Connections, 2 seats	NO17	Electropolished Ra ≤ 0.38 µm (ASME BPE SF4 / DIN HE4)
44 C	4 Connections, 4 seats, CF version	MW56	Tank bottom valve connections A and C (only GBR=32T)
44D	4 Connections, 4 seats, DFP version	MW90	Tank bottom valve connections B and C (only GBR=32T)

Key number 3: Valve size (VG)		Actuator version	
50	Robolux RV50	Actuator/Seat assignment:	
70	Robolux RV70	Construction 3C2S, 4C2S: Actuator ATR1 acts to seat U1, U2	
11	Robolux RV110	Construction 4C4S CF, 4C4S DFP: Actuator ATR1 acts to seat U1, U2 Actuator ATR2 acts to seat L1, L2	

Key number 4: Diaphragm material (DWST)	
AD	EPDM
EK	Advanced PTFE/EPDM laminated
ER	Gylon®/EPDM laminated

Key number 5: Housing material (WKST)	
VH	Stainless steel block material 1.4435/316L
VI	Stainless steel block material 1.4435 BN2/316L ASME BPE

Key number 6: Port connection (LTA)	
Listed in detail below	

Key number 7: Actuator version (ATR1, ATR2)	
D11	Dual actuator, seat 1 and seat 2 closed by spring
D12	Dual actuator, seat 1 closed by spring, seat 2 opened by spring
D21	Dual actuator, seat 1 opened by spring, seat 2 closed by spring
D22	Dual actuator, seat 1 and seat 2 opened by spring
D55	Dual actuator, seat 1 and seat 2 closed by spring, reduced spring force
000	No actuator (only ATR2; with GBR=32R, 32T, 42R)

Example: Actuator ATR1, housing 4C4S CF (44 C)
D11 = Seat U1 and U2 closed by spring
D21 = Seat U1 opened by spring and seat U2 closed by spring
Please refer to the data sheet for further details.

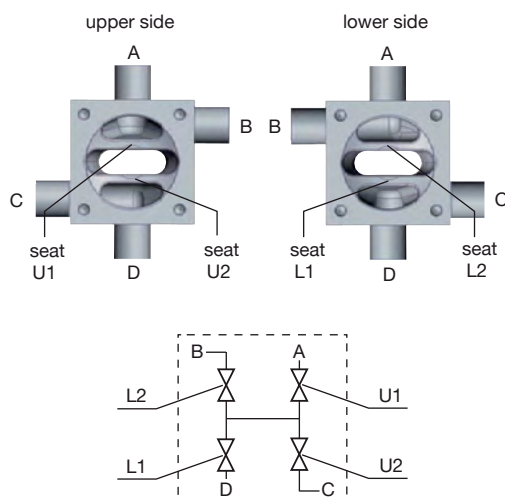









Key number 6: Port connection (LTA)

Welded connection								
Robolux size	DN		DIN EN ISO 1127 ISO 4200 DIN 11866 B	DIN 11850 2 DIN 11866 A	ASME BPE DIN 11866 C	BS4825	SMS 3008	DIN 11850 0
	[mm]	[inch]						
RV50	6	1/8"	SA78 - 10.2 × 1.6	-	-	-	-	SC41 - 8 × 1.0
	8	1/4"	SA40 - 13.5 × 1.6	-	SA90 - 6.35 × 0.89	SODB - 6.35 × 1.2	-	SC42 - 10 × 1.0
	10	3/8"	SA41 - 17.2 × 1.6	SD40 - 13 × 1.5	SA91 - 9.53 × 0.89	SODC - 9.53 × 1.2	-	-
	15	1/2"	SA42 - 21.3 × 1.6	SD42 - 19 × 1.5	SA92 - 12.7 × 1.65	SODD - 12.7 × 1.2	-	-
	20	3/4"	-	-	SA93 - 19.05 × 1.65	SODE - 19.05 × 1.2	-	-
RV70	20	3/4"	SA43 - 26.9 × 1.6	SD43 - 23 × 1.5	-	-	-	-
	25	1"	-	SD44 - 29 × 1.5	SODF - 25.4 × 1.65	SODF - 25.4 × 1.65	SA60 - 25.0 × 1.2	-
RV110	25	1"	SA44 - 33.7 × 2.0	-	-	-	-	-
	32	1"	SA45 - 42.4 × 2.0	SD45 - 35 × 1.5	-	-	-	-
	40	1"	SA46 - 48.3 × 2.0	SD46 - 41 × 1.5	SODH - 38.1 × 1.65	SODH - 38.1 × 1.65	SA62 - 38.0 × 1.2	-
	50	2"	SA47 - 60.3 × 2.0	SD47 - 53 × 1.5	SODI - 50.8 × 1.65	SODI - 50.8 × 1.65	SA63 - 51.0 × 1.2	-

Clamp connection					
Robolux size	DN		DIN 32676 series B (Pipe DIN EN ISO 1127 / ISO 4200 / DIN 11866 series B)	DIN 32676 series A (Pipe DIN 11850 series 2 / DIN 11866 series A)	ASME BPE (Pipe 11866 series A)
	[mm]	[inch]			
RV50	6	1/8"	–	TD39 - 25.0, 8.0 × 1.0	–
	8	1/4"	TC40 - 25.0, 13.5 × 1.6	TD40 - 25.0, 10.0 × 1.0	TG50 - 25.0, 6.35 × 0.89
	10	3/8"	TC53 - 25.0, 17.2 × 1.6	TD41 - 34.0, 13.0 × 1.5	TG01 - 25.0, 9.53 × 0.89
	15	1/2"	TC52 - 50.5, 21.3 × 1.6	TD42 - 34.0, 19.0 × 1.5	TG02 - 25.0, 12.7 × 1.65
	20	3/4"	–	–	TG03 - 25.0, 19.05 × 1.65
RV70	20	3/4"	TC43 - 50.5, 26.9 × 1.6	TD43 - 34.0, 23.0 × 1.5	–
	25	1"	–	TD44 - 50.5, 29.0 × 1.5	TG 04 - 50.5, 25.4 × 1.65
RV110	25	1"	TC44 - 50.5, 33.7 × 2.0	–	–
	32	1"	TC55 - 64.0, 42.4 × 2.0	TD45 - 50.5, 35.0 × 1.5	–
	40	1"	TC46 - 64.0, 48.3 × 2.0	TD46 - 50.5, 41.0 × 1.5	TG 05 - 50.5, 38.1 × 1.65
	50	2"	TC47 - 77.5, 60.3 × 2.0	TD47 - 64.0, 53.0 × 1.5	TG 06 - 64.0, 50.8 × 1.65

Control data

Control- and feedback head Type 8685 for integrated mounting on Robolux valves Type 2036		Control- and feedback head Type 8686 for integrated mounting on Robolux valves Type 2036	
	<ul style="list-style-type: none"> Contactless valve position registration Coloured illuminated status display Bus interface AS-Interface (optional) Version according to ATEX / IECEx (optional) 		<ul style="list-style-type: none"> Contactless valve position registration Coloured illuminated status display Bus interface AS-Interface (optional) Version according to ATEX / IECEx (optional)
Position feedback signal 2x inductive		Communication ASi, flat cable clamp, 1 m cable	
Supply voltage 24 V DC 8 V (Namur)		Approval II 2G Ex ia IIC T4 Gb (BVS 13 ATEX E 039 X) Ex ia IIC T4 Gb (IECEx BVS 13.0047X)	
Feedback head Type 8685	Article no.	Feedback head Type 8686	Article no.
Feedback head Robolux 24 V	231306 	Feedback head Robolux 24 V	231292 
Feedback head Robolux AS-Interface	231307 	Feedback head Robolux AS-Interface	231293 
Feedback head Robolux Exi	242249 	Feedback head Robolux Exi	242250 

DTS 1000215411 EN Version: H Status: RL (released | freigegeben | valide) printed: 27.08.2020